



WITHROW KITCHEN FAUCET INSTALLATION

BEFORE YOU BEGIN

We recommend consulting a professional if you are unfamiliar with installing plumbing fixtures. Signature Hardware accepts no liability for any damage to the faucet, plumbing, sink, counter top, or for personal injury during installation.

Observe all local plumbing and building codes.

Unpack and inspect the faucet for shipping damage. If any damage is found, contact our Customer Relations team at 1-866-855-2284.

GETTING STARTED

- Ensure that you have gathered all the required materials that are needed for the installation.
- For these instructions, it is assumed that the old faucet has been completely removed and any necessary repairs or modifications to the water supply have been completed.

TOOLS AND MATERIALS:



Plumbers
Tape



Thread
Sealant



Phillips
Screwdriver



Adjustable
Wrench



Small
Bucket



WITHROW KITCHEN FAUCET INSTALLATION

Installation

1. Ensure that the water supply below your sink is completely shut off by turning the shutoff valves all the way to the right.

Tip: Place a small bucket below your workspace to catch any water that may drip during the installation process.

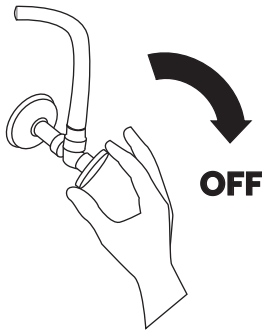

2. Remove the lock nut and brass spacer from the faucet body. Slide the tapered metal washer onto the faucet body followed by the rubber gasket, and insert into the base of the faucet as shown. The tapered side of the washer should face up.

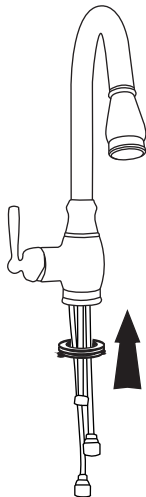

3. Insert the faucet into its mounting hole. From beneath the sink, slide the brass spacer back onto the faucet body. Thread the locknut back onto the threaded shank until hand-tight to secure. Finish tightening using an adjustable wrench.

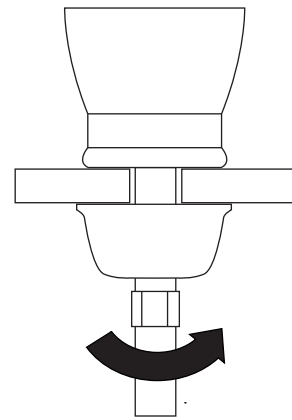

4. Attach the sprayer hose to its copper mounting post as shown. Insert the provided rubber O-ring into the lock nut before securing. Apply a bit of thread sealant or plumber's tape to the threads before tightening.

Important: Hand tighten, then use an adjustable wrench to give the lock nut no more than a ¼ turn to complete tightening. Do not overtighten, which can crack or break the copper mounting post.

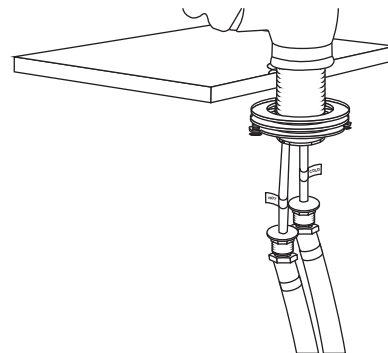



WITHROW KITCHEN FAUCET INSTALLATION

5. Disassemble the provided hand sprayer hose weight by removing the two screws with a Phillip's screwdriver. From beneath the counter, measure 15" down the hose from the faucet body. The weight will need to be mounted at this location. Clamp the two sides of the weight together and tighten the screws to secure.

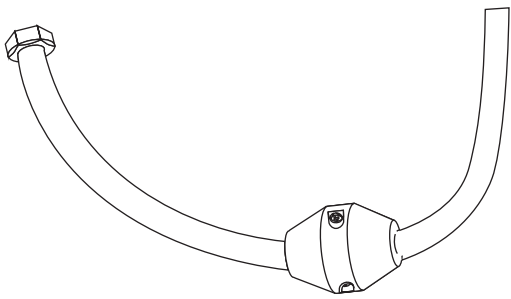

6. Attach your main water lines to the copper water supply posts on the faucet. Ensure that you are connecting the hot and cold in accordance with the labels on the supply posts. Apply a bit of thread sealant or plumber's tape to the threads before tightening.

Important: Hand tighten, then use an adjustable wrench to give the lock nut no more than a ¼ turn to complete tightening. Do not overtighten, which can crack or break the copper mounting post.

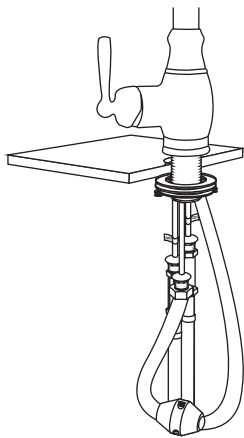

7. Once installation is complete, turn the main water supply back on from underneath your sink. Check for any leaks underneath.

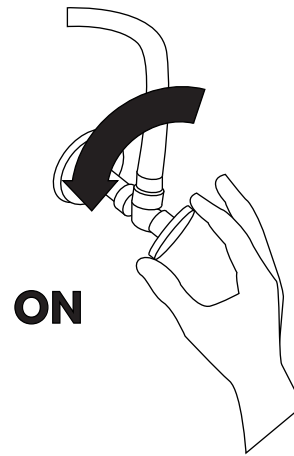

8. Turn the faucet on and ensure that there are no leaks. Check to ensure that both hot and cold water are running properly. Turn on the hand sprayer function and allow the sprayer to run for another 60 seconds, and check for any leaks.

