



# CAELI THERMOSTATIC SHOWER PANEL

## BEFORE YOU BEGIN

We recommend consulting a professional if you are unfamiliar with installing plumbing fixtures. Signature Hardware accepts no liability for any damage to the plumbing, floor, walls, tub, or for personal injury during installation.

Observe all local plumbing and building codes.

Unpack and inspect the item for shipping damage. If any damage is found, contact our Customer Relations team at 1-866-855-2284.

---

## GETTING STARTED

- Ensure that you have gathered all the required materials that are needed for the installation.
- Before you begin, the main water supply to your home should be shut off.

## TOOLS AND MATERIALS:



Plumbers  
Tape



Tape Measure



Level



Adjustable  
Wrench



Drill



Pencil or  
Marker



# CAELI THERMOSTATIC SHOWER PANEL

## Installation

1. Before installation, complete the in-wall plumbing. The hot and cold water lines should be prepared no more than 4" on-center. Male fittings will be needed to make the connection to the shower panel's water lines.

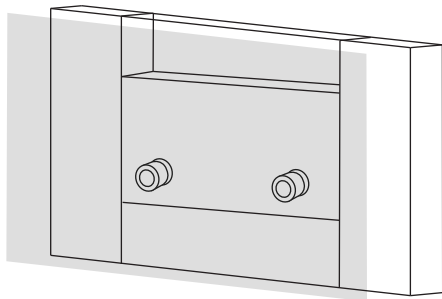

2. With the assistance of another person, hold the shower panel up to the wall at the desired mounting location. Use a level to ensure that the shower panel is aligned straight.

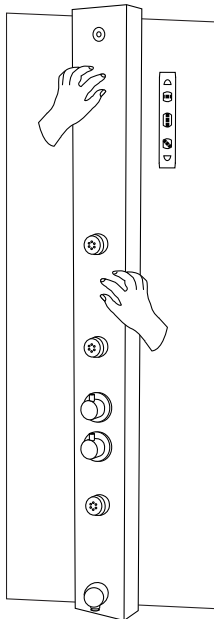

3. Once properly positioned, mark the locations of the upper and lower mounting brackets on the wall. Make a small mark on each side of the panel for each bracket, then set the shower panel aside. Draw a horizontal line from one mark to the next for each bracket, using a level for guidance.

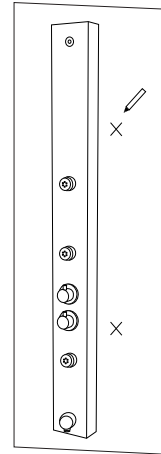

4. Hold the provided mounting brackets up to the marked locations on the wall. Center each of the mounting brackets on their marked horizontal lines and mark the locations of the mounting holes on the wall.

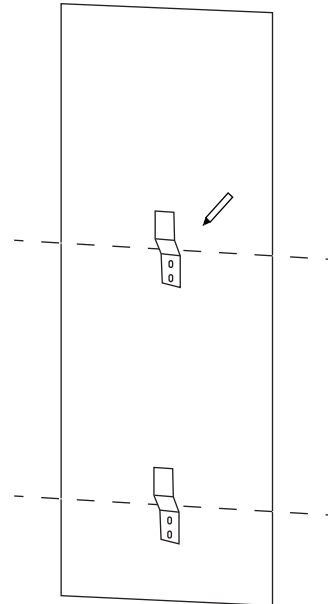



# CAELI THERMOSTATIC SHOWER PANEL

5. Drill pilot holes into the wall at the marked mounting hole locations. Insert one of the provided anchors into each of the four holes.

**Important:** If drilling through tile, you must use a masonry drill bit. Drill very carefully to avoid cracking the tile.

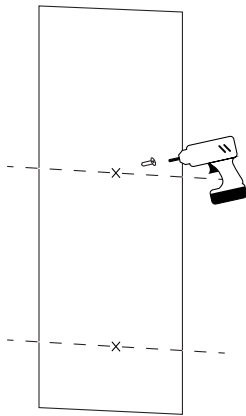

6. Attach the mounting brackets to the wall as shown, using the provided screws.

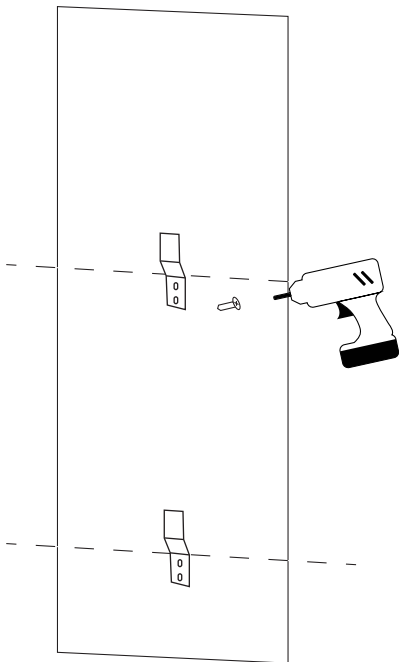

7. Attach the shower arm to the shower panel. Remove the lock nut and rubber from the shower arm, and insert it into its mounting hole. Slide the rubber washer onto the back of the shower arm, then secure using the lock nut. Tighten the lock nut firmly with an adjustable wrench.

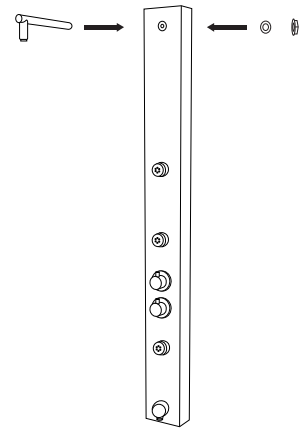

8. Attach the shower arm's supply hose to the shower arm. Insert one of the provided screen washers into the end of the hose, and apply plumber's tape to the threads before attaching. Hand tighten the hose onto the threaded shank, then finish tightening using an adjustable wrench.

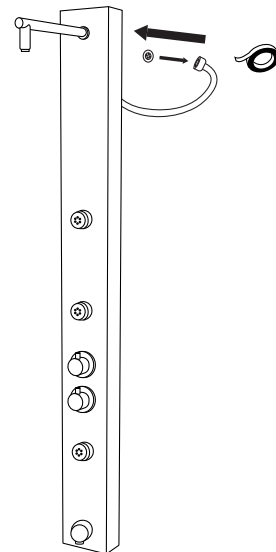



# CAELI THERMOSTATIC SHOWER PANEL

9. Connect the shower panel's water lines to their installed male fittings on the wall. Ensure that you are connecting the hot and cold lines appropriately. Apply plumber's tape to the threads before attaching. Tighten using an adjustable wrench.

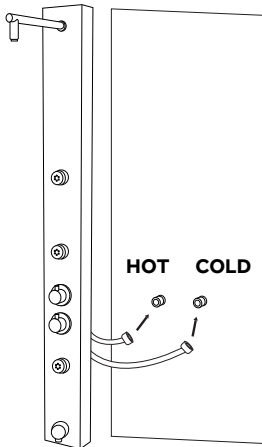

10. Hang the shower panel onto the wall. Position the panel so that it is centered on the installed mounting brackets.

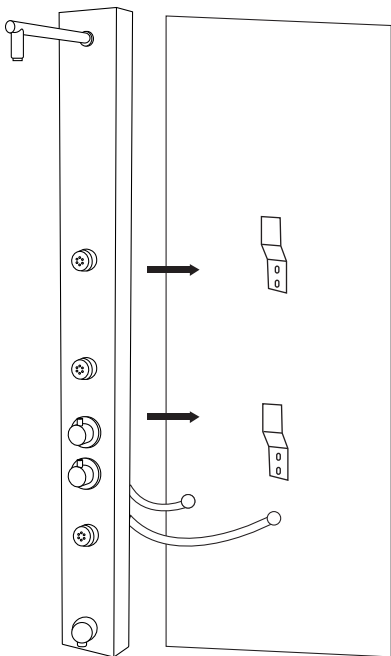

11. Determine a location to mount the hand shower's cradle. Hold the cradle up to the wall and mark the location of each of the mounting holes.

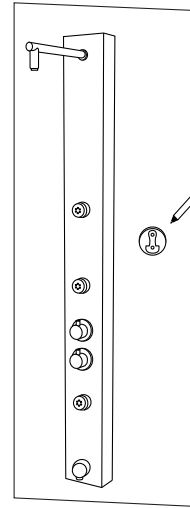

12. Drill pilot holes into the wall at the marked mounting hole locations. Insert one of the provided anchors into each of the two holes.

**Important:** If drilling through tile, you must use a masonry drill bit. Drill very carefully to avoid cracking the tile.

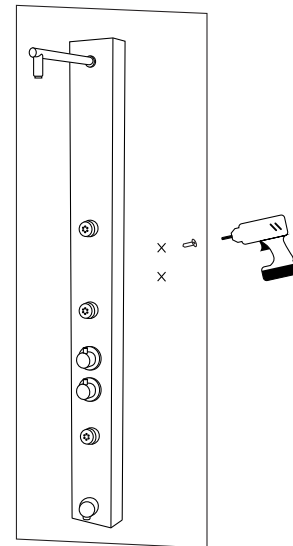



# CAELI THERMOSTATIC SHOWER PANEL

13. Secure the hand shower cradle to the wall using the provided screws.

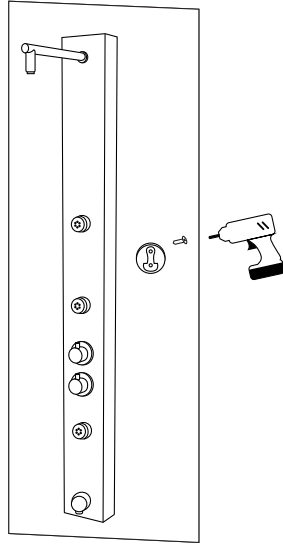

14. Attach the hand shower to the shower panel using the provided metal hose, as shown. Hand tighten each connection firmly.

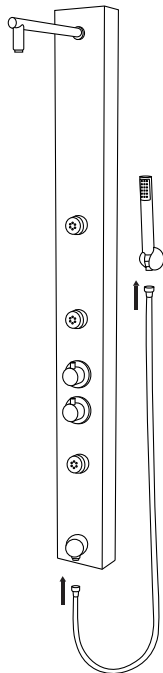

15. Complete the installation by installing the shower head onto the shower arm. Hand tighten the shower head onto the arm, then finish tightening using an adjustable wrench. Apply plumber's tape to the threads before attaching.

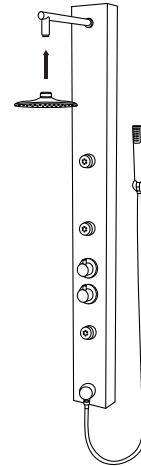

16. Turn the main water supply back on, and test the installed shower panel. Ensure that there are no leaks and that all functions are working properly.

