



ALLISTON EXPOSED PIPE SHOWER SET

BEFORE YOU BEGIN

We recommend consulting a professional if you are unfamiliar with installing plumbing fixtures. Signature Hardware accepts no liability for any damage to the plumbing, floor, walls, tub, or for personal injury during installation.

Observe all local plumbing and building codes.

Unpack and inspect the item for shipping damage. If any damage is found, contact our Customer Relations team at 1-866-855-2284.

GETTING STARTED

- Ensure that you have gathered all the required materials that are needed for the installation.
- For the following instructions, it is assumed that the in-wall plumbing has been prepared and the finished wall is in place.

TOOLS AND MATERIALS:



Plumbers
Tape



Thread
Sealant



Adjustable
Wrench



Level



Tape Measure



Drill



Pencil or
Marker



Hex Wrench



ALLISTON EXPOSED PIPE SHOWER SET

Installation

1. To prepare for installation, two female 1/2" NPT fittings should be prepared, recessed 3/8" behind the finished wall. Fittings should be positioned 5 1/2" - 7" apart on center.

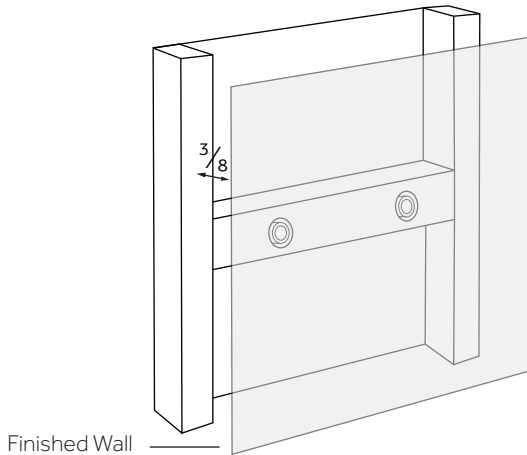

2. Apply thread sealant or plumber's tape to the 1/2" end of the provided pipe nipples. Screw each nipple into the prepared female fittings. Tighten until the nipples extend 1-3/8" beyond the finished wall.

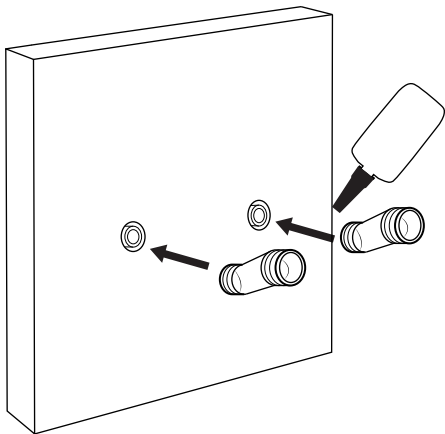

3. Screw the provided decorative escutcheons onto the installed pipe nipples. Hand-tighten firmly against the wall.

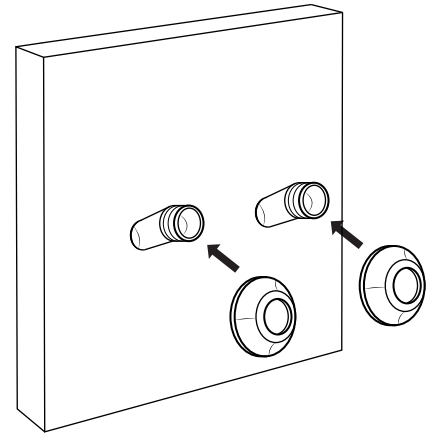

4. Insert each of the provided rubber washers into the back of the faucet. Apply thread sealant or plumber's tape to the installed pipe nipples, then attach the faucet. Use an adjustable wrench to tighten firmly.

Tip: Wrap the nuts with a soft cloth before tightening with a wrench, to avoid scratching the plated finish.

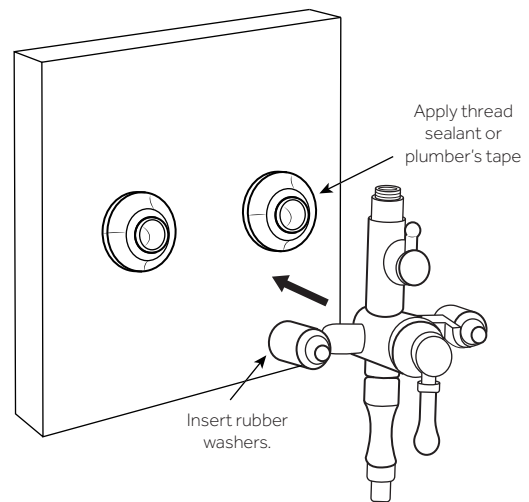



ALLISTON EXPOSED PIPE SHOWER SET

5. Attach the shower arm elbow to the top of the shower riser pipe. Hand tighten firmly.

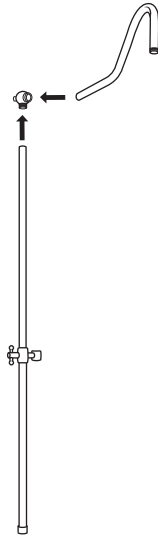

6. Temporarily install the riser pipe onto the installed valve assembly. Do not yet apply thread sealant or plumber's tape to the threads, as the riser will need to be removed to install the upper mounting plate.

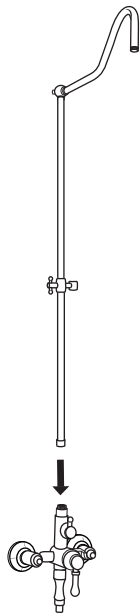

7. Slide the mounting plate onto the riser pipe's rear support arm, as shown. Position the mounting plate on the wall at its desired location. Use a level to ensure that the riser pipe is straight, then mark the location of the mounting holes of the plate on the wall using a pencil or marker.

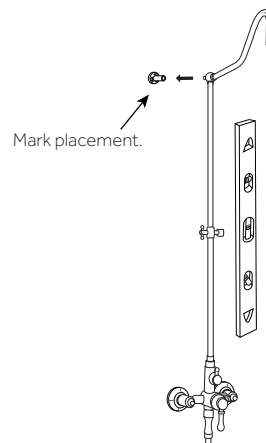

8. Remove the mounting plate and riser pipe assembly. Drill pilot holes at the marked locations on the wall, and insert the provided anchors. Attach the mounting bracket to the wall using the provided screws.

Important: If drilling through tile, you must use a masonry drill bit to avoid cracking or breaking the tile.

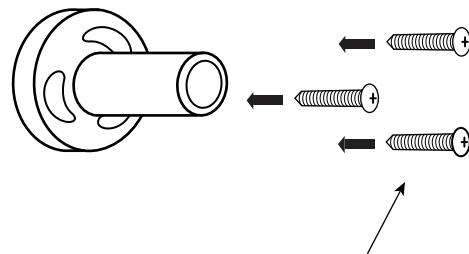

Use screws after anchors are inserted into pilot holes.



ALLISTON EXPOSED PIPE SHOWER SET

9. Slide the decorative flange onto the mounting plate to conceal the mounting hardware.

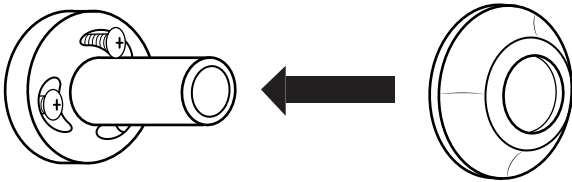

10. Reattach the riser pipe to the valve. Ensure that the rear support arm on the riser pipe slides into the installed upper mounting plate. Apply plumber's tape or thread sealant to the threads on the valve before attaching, and tighten the nut on the riser pipe using an adjustable wrench. Once secure, tighten the set screw located on the upper mounting plate using the provided hex wrench.

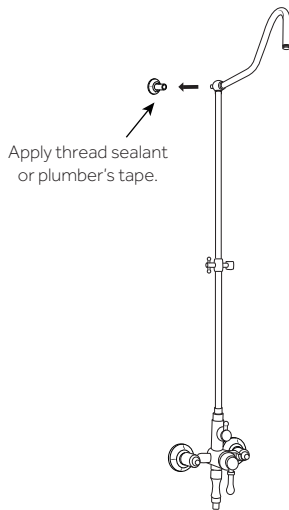

11. Attach the shower arm to the shower arm elbow, then attach the shower head to the shower arm. Install the handheld shower using the provided flexible hose. Apply thread sealant or plumber's tape to all the threads before attaching.

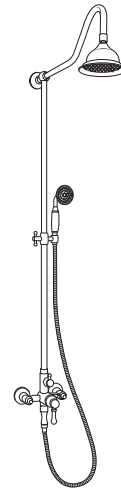

12. Once installation is complete, turn the system on for testing. Divert the water to the hand shower. Check to ensure that there are no leaks from any of the connections, and that both functions are working properly.

