

# 60" X 36" SITKA

## ACRYLIC DROP-IN TUB

SKU: 948264



### CONTENTS

AIR & WHIRLPOOL TUB .....	PAGE 2
60" X 36 TUB .....	PAGE 3

### FEATURES

Textured slip-resistant bottom.  
Pre-leveled base.  
Cut out template included.  
57-gallon (215.8-Liters) operating capacity.  
Intuitive electronic control pad.  
Tub Options:  
Soaking - No air feature.  
Air - 56 Air jets circulate warm air throughout the tub, creating warm bubbles for a massaging, rejuvenating experience.  
Whirlpool - 8 Strategically placed air jets move water with increased pressure for an invigorating bathing experience.  
Air Bath system uses a 9.25 amp, 600 watt heated blower for air bath system.  
Whirlpool system uses a powerful 1.75hp, 9 amp whirlpool pump.  
Safety Suction: Meets all requirements of durability and clog-resistance through standard testing.  
Pre-wired for simple plug-in installation.  
ABS drain version available if needed for your installation.  
Optional Quick Connect Drop-In Drain Kit Includes:  
Floor Plate, 1-1/2" PVC Pipe, 2" x 1-1/2" Trap Adapters, 1 Brass Threaded, 1 Brass Unthreaded Tailpiece and Plug.  
Installs above your subfloor, but underneath your cement floor or tile, so you do not need access below the fixture.  
A dual-mount design, this can be installed as a drop-in or undermount tub.

### SIGNATURE HARDWARE Lifetime Warranty

See website for detailed warranty information.

REVISED 10/26/2021

CODE: SHSKA6036WH/SHSKS6036WH/SHSKW6036WH/SHSKS6036BS/SHPRESSHTR/PFTLK

# AIR TUB AND WHIRLPOOL TUB

## COMPONENTS LIST

- Powerful whirlpool pump with variable flow device
- Heated blower for air bath system

## INSTALLATION

- Whirlpool and Total Massage units require dedicated 20 Amp, 120V service
- You must provide a receptacle with a 20 Amp configuration
- Electrical outlet must be mounted 4" (101mm) above the floor line and 12" max (305mm) inside from the edge of the bathtub, or in accordance with local building and electrical codes

## INTEGRATED CONTROL PANEL

- Intuitive electronic control buttons

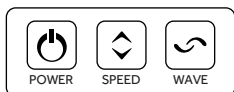
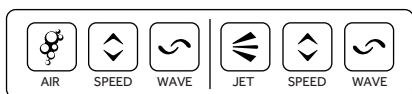

## INSIDE OF BATH

- (8) HIGH-FLOW DIRECTIONAL AND VOLUME-ADJUSTABLE WHIRLPOOL JETS
- (56) CHANNEL-FED AIRJETS (air bath and total massage)



WHIRLPOOL JET

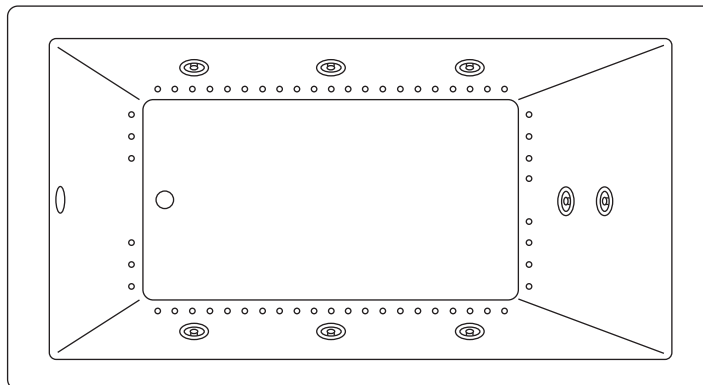

## ELECTRICAL CONFIGURATIONS

### WHIRLPOOL CIRCUIT WITH OPTIONAL HEATER

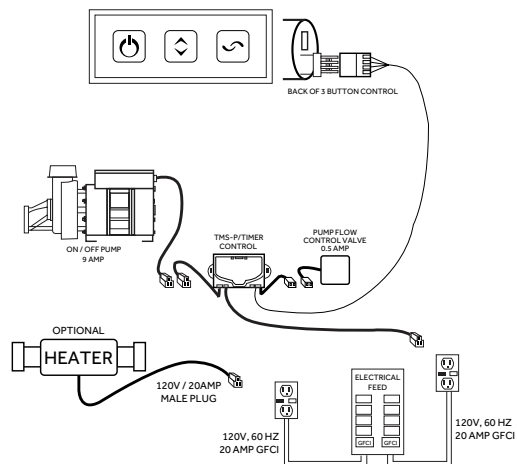

### TOTAL MESSAGE CIRCUIT WITH OPTIONAL HEATER

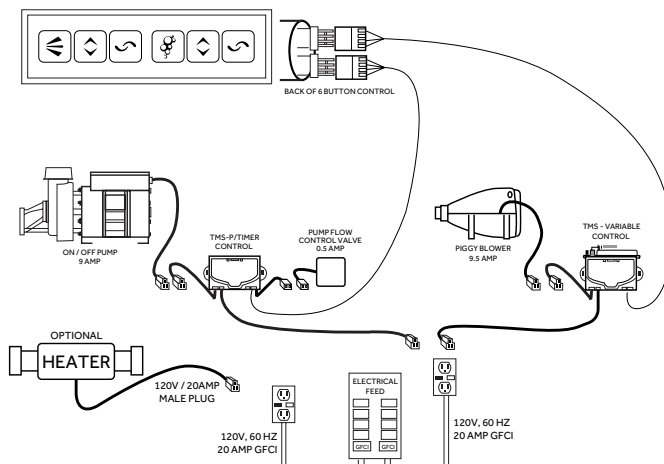

### AIR MESSAGE CIRCUIT

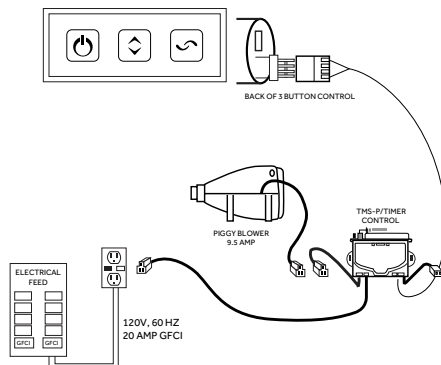

# 60" X 36" SITKA

## ACRYLIC DROP-IN TUB

SKU: 948264

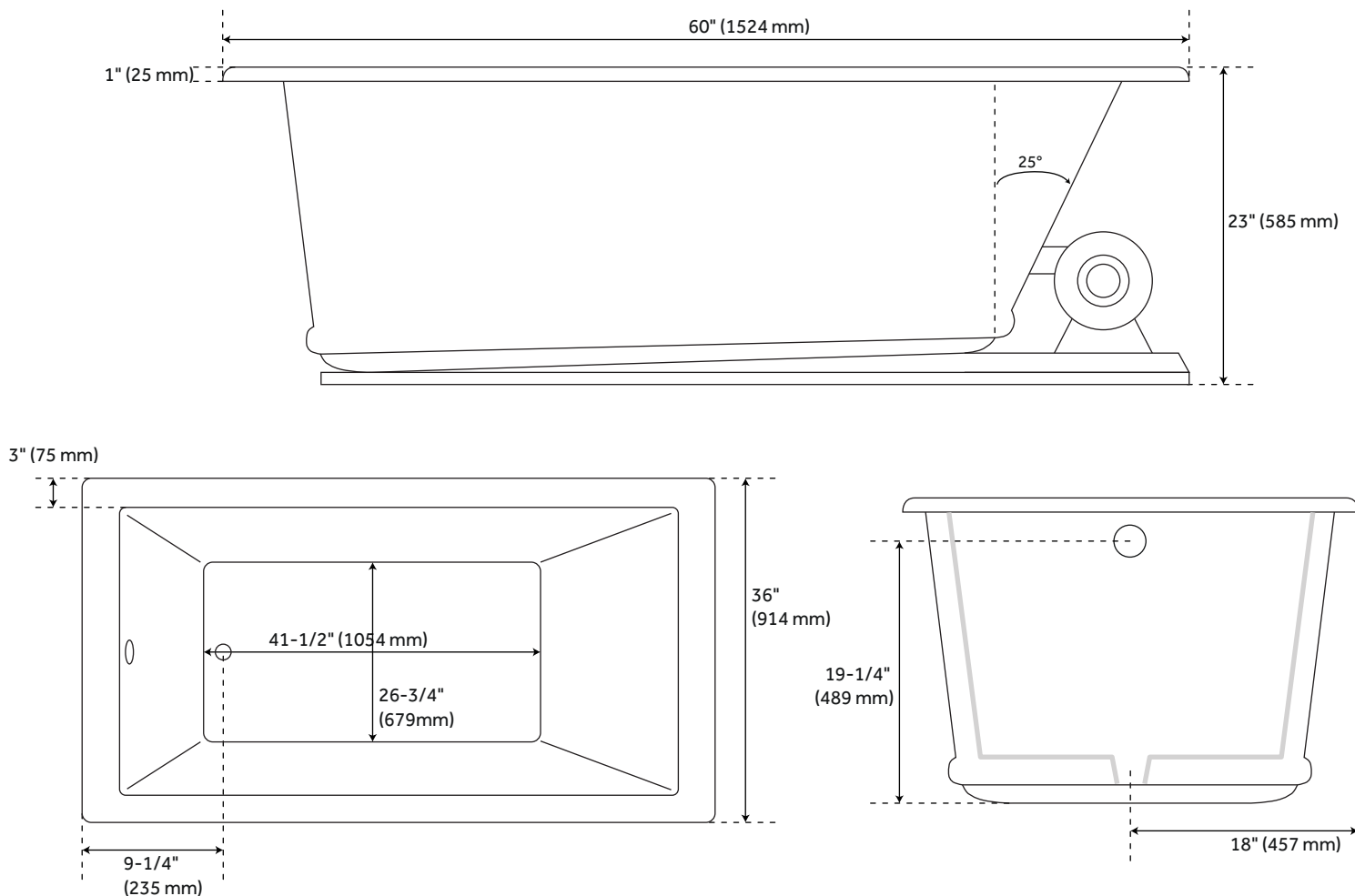

### FEATURES

Product Finish: White  
Overflow Hole: Yes  
Shape: Rectangle  
Material: Acrylic  
Length: 60"  
Width: 36"  
Height: 23"  
Tub Interior Length: 41-1/2"  
Tub Interior Width: 26-3/4"  
Water Depth To Overflow: 19-1/4"  
Drain Included: Optional  
Drain Placement: End  
Faucet Included: No  
Water Capacity (Gallons): 65  
All dimensions ( $\pm 1/2"$ ).

### SOAKING TUB CODES/STANDARDS

cUPC  
CSA B45.5/IAPMO Z124  
Massachusetts Accepted

### WITH OPTIONAL AIR SYSTEM CODES/STANDARDS

cUSPC  
ASME A112.19.7/CSA B45.10  
UL 1795  
CSA C22.2 No. 218.2

### SIGNATURE HARDWARE LIFETIME WARRANTY

See website for warranty information

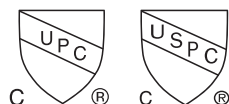

All dimensions and specifications are nominal and may vary. Use actual products for accuracy in critical situations.

PAGE 3