

67" Cast Iron Slipper on Feet

Tub Dimensions: 67" L x 29" W x 22-29" H

Tub water capacity: 57 gallons

Tub Weight Uncrated: 300 lbs. Tub Weight Crated: 410 lbs.

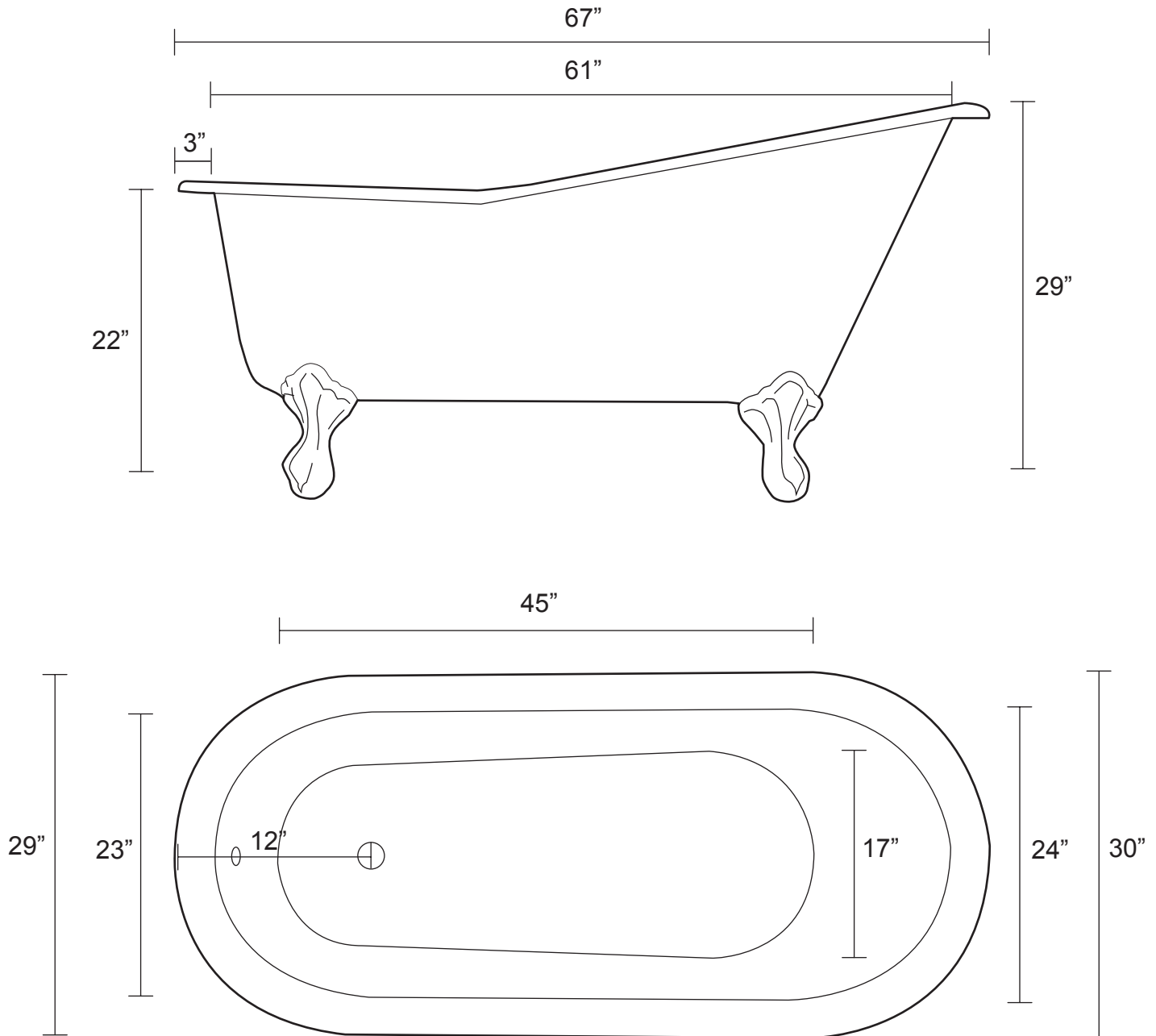

Tub is 17" deep at drain.

Overflow hole diameter is 1-1/2"

Water depth to overflow is 13-1/2" H

All measurements are approximate. Measurements may vary +/- 1/2".