

68" Cast Iron Rolled Rim Tub on Feet

Tub Dimensions: 68" L x 30-1/2" W x 22-3/4" H

Tub water capacity: 55 gallons

Tub Weight Uncrated: 266 lbs. Tub Weight Crated: 446 lbs.

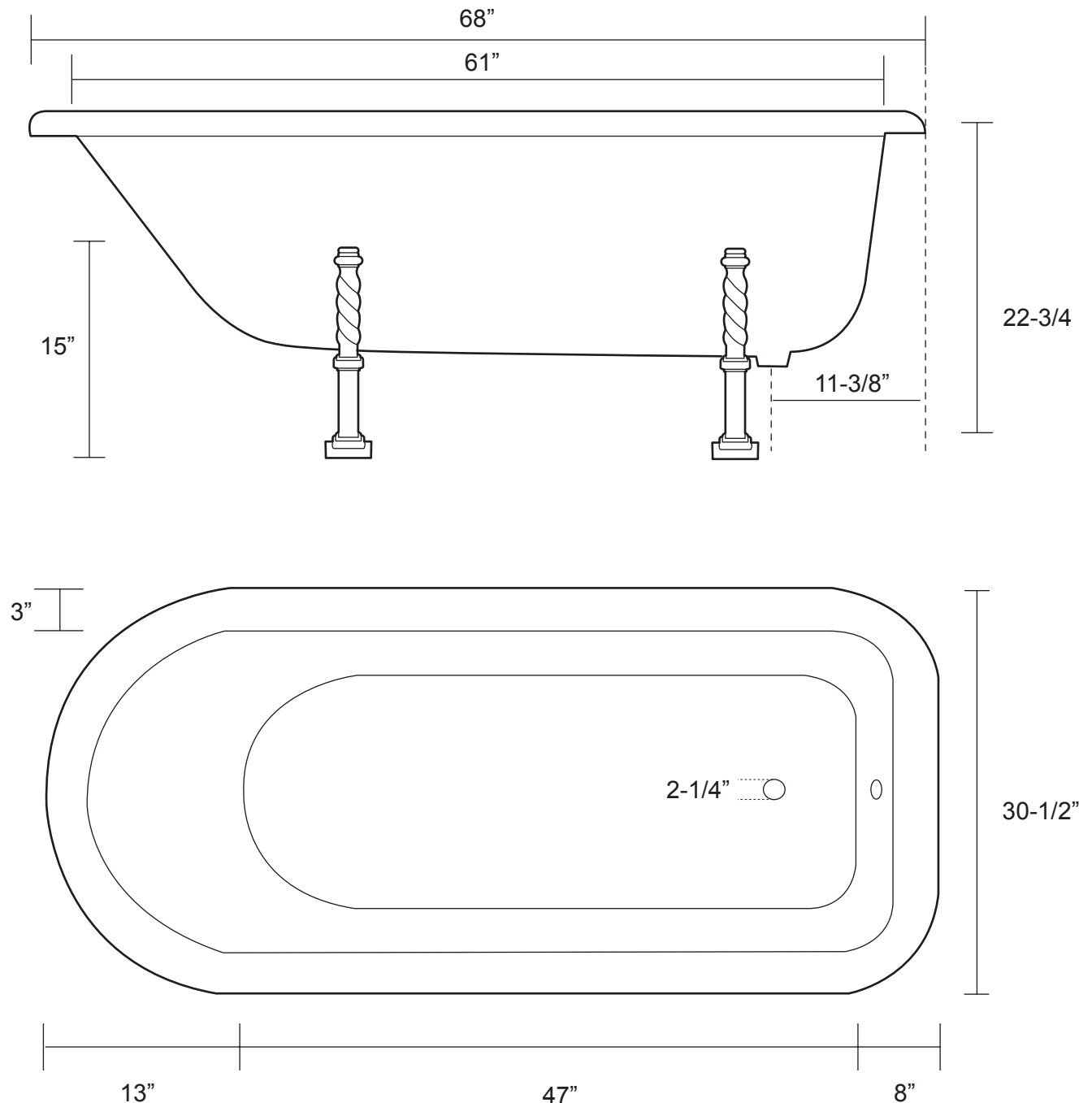

Tub is 18" deep at drain.

Overflow hole diameter is 1-1/2".

Water depth to overflow is 15-1/2" H for Rim Mount / 13" H for Wall Mount Faucet Drilling.

All measurements are approximate. Measurements may vary +/- 1/2".