

61" Cast Iron Rolled Rim Tub on Feet

Tub Dimensions: 61" L x 30-1/2" W x 23-1/2" H

Tub water capacity: 50 gallons

Tub Weight Uncrated: 324 lbs. Tub Weight Crated: 504 lbs.

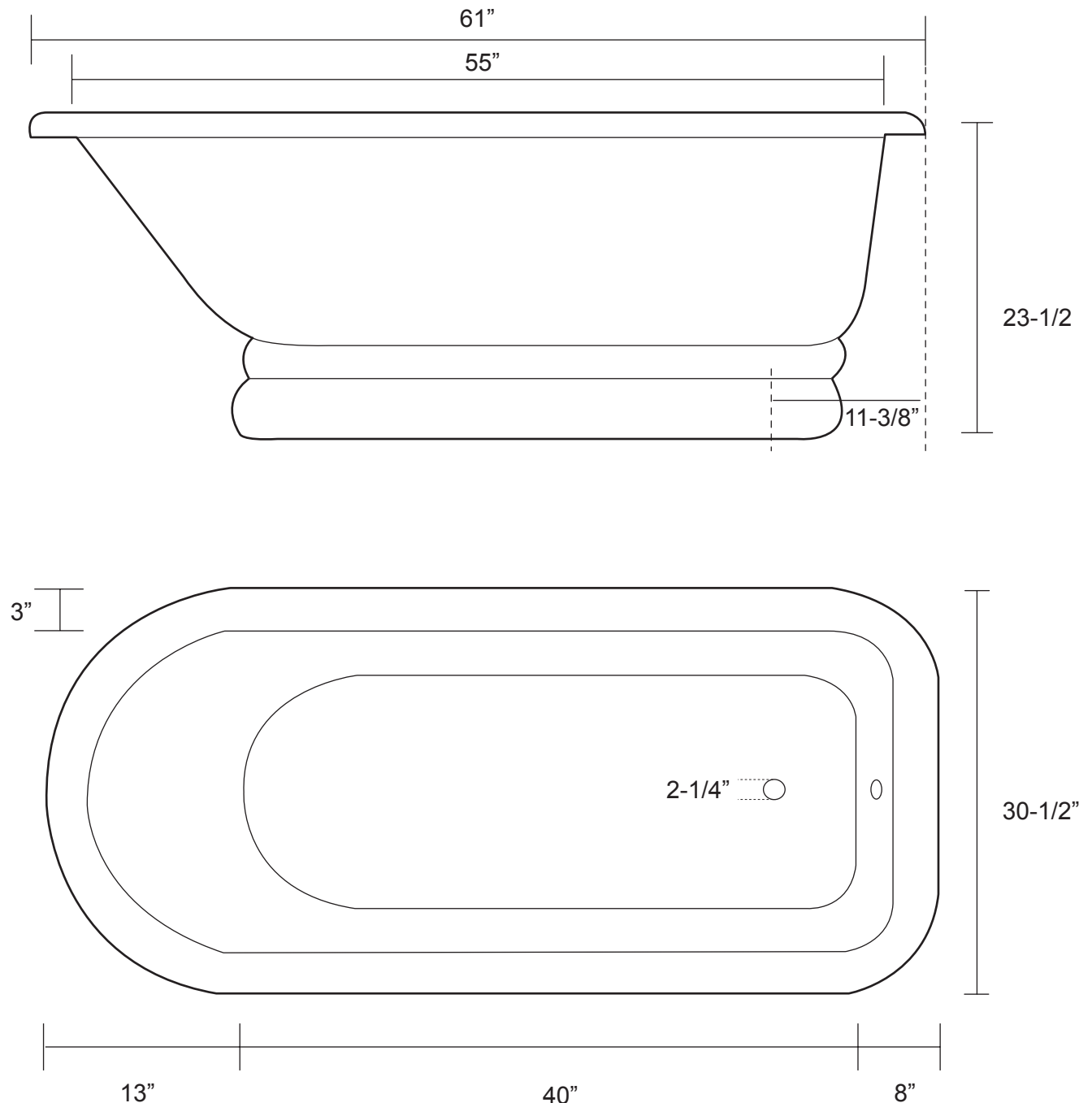

Tub is 18" deep at drain.

Overflow hole diameter is 1-1/2".

Water depth to overflow is 15-1/2" H for Rim Mount / 13" H for Wall Mount Faucet Drilling.

All measurements are approximate. Measurements may vary +/- 1/2".